



Main characteristics

- ONDA technology
- Optimized mechanical structure
- Strokes from 50 to 4000 mm
- Wide range of connectors for the electrical connection
- Rod, nipple, exagonal flange AISI 316
- Work temperature: -30°...+75°C
- Resistance to vibrations (DIN IEC68T2/6 12g)
- Power supply 24Vdc ± 20%
- Protection IP67

Contactless linear position transducer with ONDA magnetostrictive technology.

The analog interface, available with various output ranges in voltage or in current, guarantees simpler installation and easier adaptation to existing systems.

The absence of electrical contact on the cursor eliminates all wear and guarantees almost unlimited life.

The IK4 mechanical structure introduces some innovations for using in-cylinder, including free rotation of the connector head.

TECHNICAL DATA

Model	from 50 to 4000 mm
Measurements	displacement
Position read sampling time (typical)	From 0,5 ms to 3 ms (depending on stroke)
Shock test DIN IEC68T2-27	100g - 11ms - single shock
Vibration DIN IEC68T2-6	12g / 10...2000Hz
Displacement speed	≤ 10 m/s
Max. acceleration	≤ 100 m/s ² displacement
Resolution	16 bit (max noise 5 mVpp)
Cursor	Floating separate cursor
Working temperature	-30...+75°C
Storage temperature	-40...+100°C
Coefficient of temperature	≤ 0,01% F.S./°C
Protection	IP67
Operative pressure	350 bar (peak max. 500 bar)

ELECTRICAL DATA

Output signal	0...10V (A)	4...20mA (E) 0...20mA (G)
Nominal power supply	24 Vdc ±20%	24 Vdc ±20%
Max. power ripple	1Vpp	1Vpp
Max. consumption	70mA	90mA
Load on output	5kΩ	< 500Ω
Max. output noise	< 5mVpp	< 5mVpp
Max. output value	12V	30mA
Alarm output value	10.5V	21mA
Electrical isolation	500V (*)	500V (*)
Protection against polarity inversion	Yes	Yes
Protection against overvoltage	Yes	Yes
Protection against power supply on output	Yes	Yes

(*) Using voltage suppressor 30V 0,4J

ELECTRICAL / MECHANICAL DATA

Model	50	100	130	150	200	400	450	500	600	700	750	800	900	1250	1500	1750	2000	2250	2500	2750	3000	3250	3500				
	225	300				1000																	3750	4000			
Sampling time	ms	0,5				1							1,5			2			3								
Dimensions Max. (A)	mm	Model +176,2											Model +181,2														
Electrical stroke	mm	Model																									
Independent linearity		≤ ± 0,02% FS (min ± 0,060 mm)																									
Repeatability	mm	< 0,01																									
Hysteresis	mm	< 0,01																									

MECHANICAL DIMENSIONS

Strokes from 50 to 1000 mm

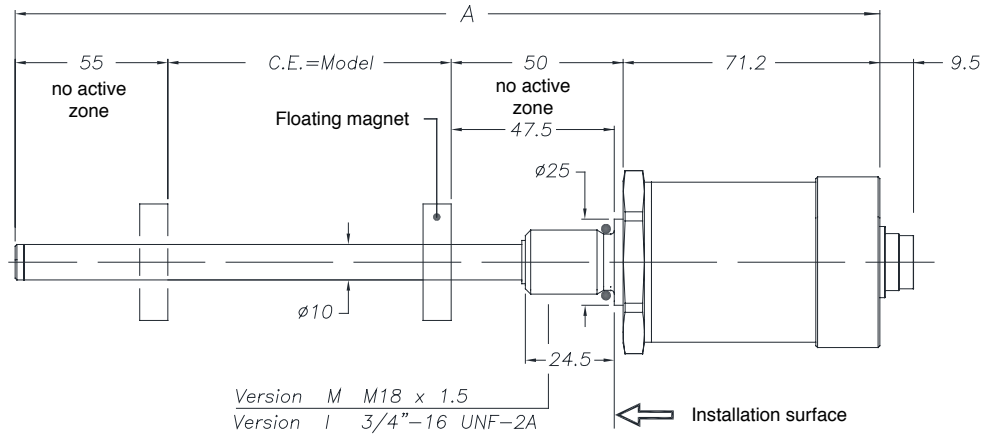

Strokes from 1250 to 4000 mm

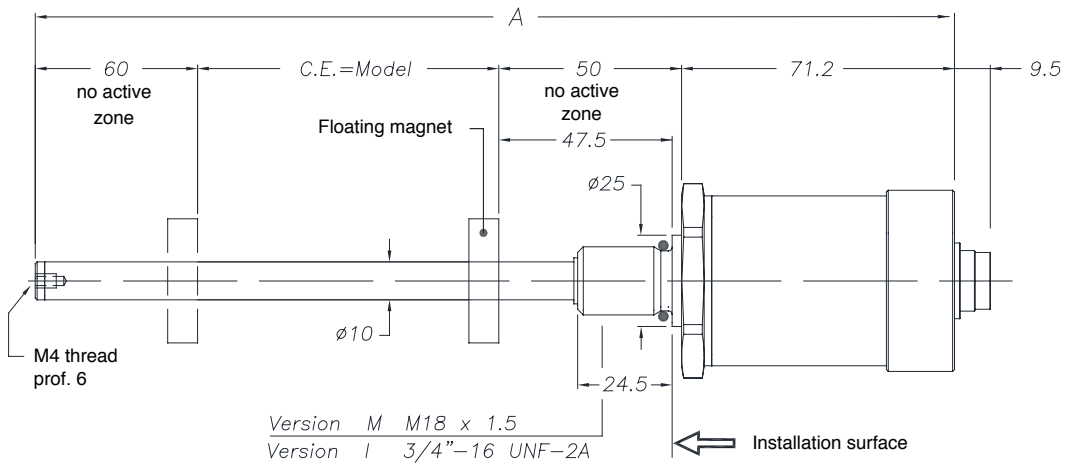

IK4-A-F/R cable output

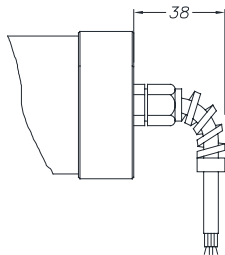

IK4-A-A/B/C/H connector output

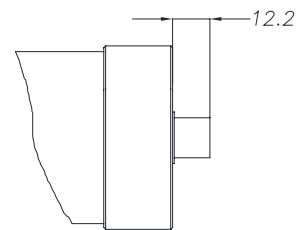

MOUNTING INSIDE A CYLINDER

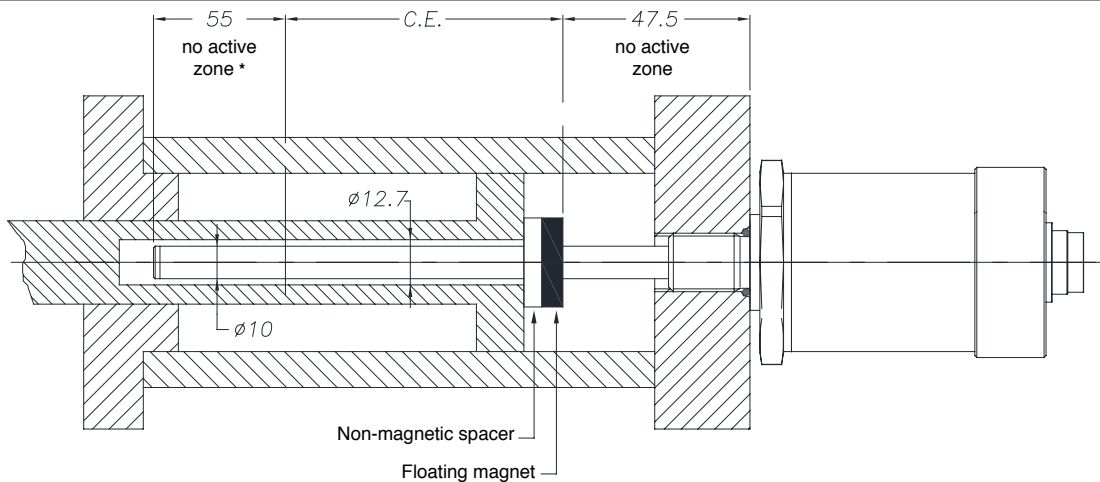

* for stroke up to 1000 mm (included) – over 1000 mm, the non-active zone becomes 60 mm because the tip includes a M4 threaded hole

INSTALLATION INSIDE A CYLINDER

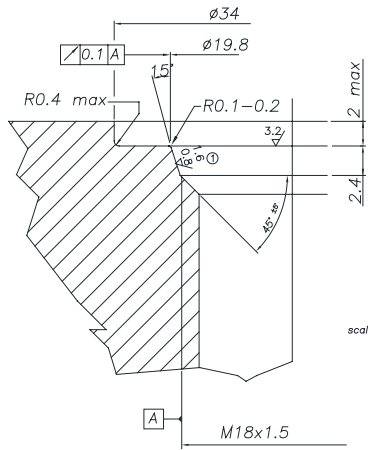

- ① **THREAD M18x1,5**
 The sealing surface must be free from scratches longitudinal or spiral
 Ro 1.6 µm for sealing with NON-pulsating pressure
 Ro 0.8 µm for seals with pulsating pressure

Suggested o-ring:
 PARKER 6-349 15,4x2,1
 Material: Viton 90° Shore-A
 Mixes: PARKER N552-90

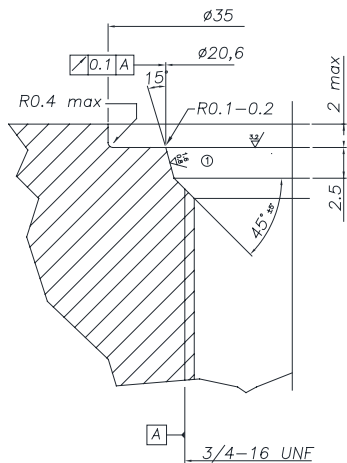
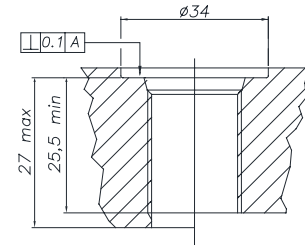

- ① **THREAD 3/4"-16UNF**
 The sealing surface must be free from scratches longitudinal or spiral
 Ro 1.6 µm for sealing with NON-pulsating pressure
 Ro 0.8 µm for seals with pulsating pressure

Suggested o-ring:
 PARKER 3-908 16,36x2,21
 Material: Viton 90° Shore-A
 Mixes: PARKER N552-90

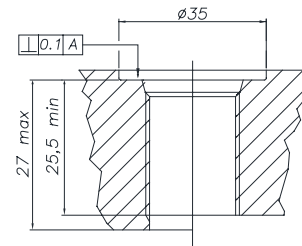

ELECTRICAL CONNECTIONS

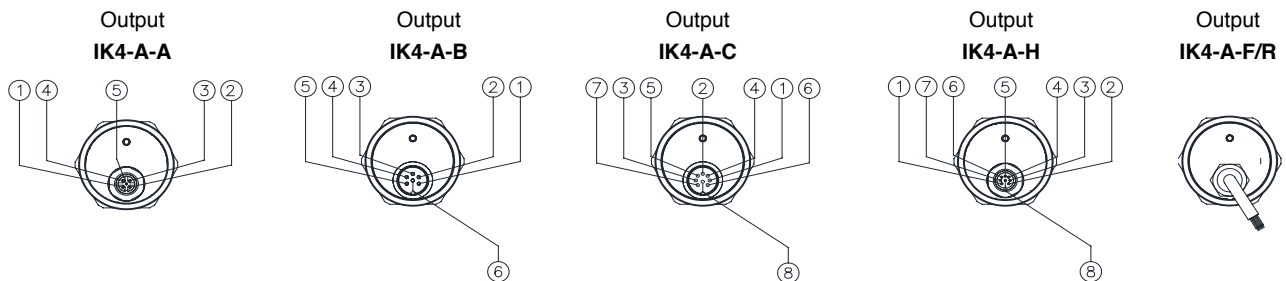

Function	CONNECTORS				CABLES	OPTIONAL CABLES	
	IK4-A-A	IK4-A-B	IK4-A-C	IK4-A-H	IK4-A-F/R	CAV00_	CAV01_/CAV02_
	5 pin M12	6 pin M16	8 pin M16	8 pin M12	Standard cables	Pre-assembled cable 8 pin IK4A-H	Pre-assembled cable 5 pin IK4A-A
Output 1 (position) 0...10V 4...20mA 0...20mA	1	1	5 (1*)	5	Grey	Green	Brown
GND Output 1 (0V)	2	2	2	1	Pink	Yellow	White
Output 2 (inverse position) 10...0V 20...4mA 20...0mA	3	3	3	3	Yellow	Pink	Blue
GND Output 2 (0V)	2	4	6	2	Green	Grey	White
Power supply +	5	5	7	7	Brown	Brown	Grey
Power supply GND	4	6	8	6	White	Blue	Black
n.c.	-	-	4	4	-	Red	-
n.c.	-	-	1 (*5)	8	-	White	-

GROUNDING IK4

Connector output **IK4-A-A/B/C/H**

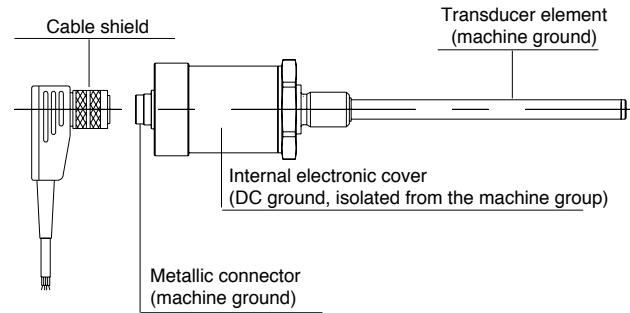

Cable output **IK4-A-F/R**

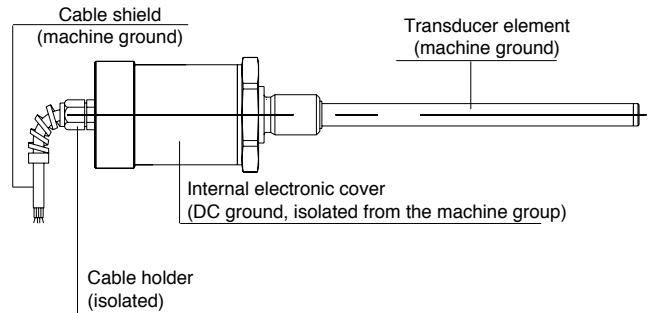

ANALOG OUTPUT

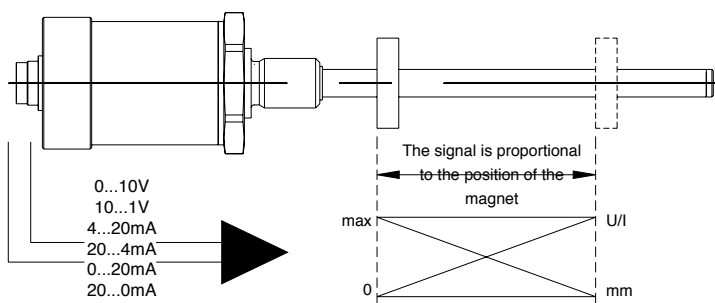

The magnetostrictive transducers of the IK4 series supply a direct analogue output in voltage (0...10Vdc) and current (4...20mA and 0...20mA).

All the outputs can have reverse action (10...0Vdc; 20...4ma; 20...0mA).

The outputs are direct, no signal conditioning is required if they are interfaced with a controller or measuring instrument.

ORDER CODE

Position transducer

I K 4 A [] [] [] [] [] 1

Analog output

A

Output Connector

M12 5 pin output connector	A
6 pin DIN 45322 output connector	B
8 pin DIN 45326 output connector	C
M12 8 pin output connector	H
PVC 7 pin 7x0,25 output cable	F
PUR 7 pin 7x0,14 output cable high flexibility	R

MODEL

Output

0...10, 10...0 Vcc	A
4...20, 20...4 mA	E
0...20, 20...0 mA	G

0 0 0 0 X X X X S [] [] [] 0 X X

Cable lengths

Output F/R	
1mt	00
2mt	02
3mt	03
4mt	04
5mt	05
10mt	10
15mt	15
Output A/B/C/H	00

Thread

M 18x1.5 (standard)	M
3/4" - 16UNF	I

Included in the supply

- Series IK position transducer
- OR 15.4 x 2.1 thread M18 x 1.5 cod: **GUA064**
- OR 16.36 x 2.21 thread 3/4" -16 UNF cod: **GUA065**

Magnetic cursors must be ordered separately

Mechanical and/or electrical characteristics differing from those in the standard version may be arranged on request.

Ex.: **IK4-A-B-0400-A-1 0000XXXXS00M0XX**

Transducer model IK4, analog output, B connector, model 400mm, 0...10Vdc output, thread M18x1,5

FLOATING CURSOR



Cursors	
Cursor Diameter 32.8	022
Cursor Diameter 32.8 with 90° slit	023
Cursor Diameter 25.4	024
Floating cursor for liquids with hole diameter 12	026
Floating cursor for liquids with hole diameter 15	027

The **PCUR022** is supplied with:
 N° 8 Brass nuts M4
 N° 8 Brass washers D4
 N° 4 Brass screws M4x25

The **PCUR023** is supplied with:
 N° 4 Brass nuts M4
 N° 4 Brass washers D4
 N° 2 Brass screws M4x25

Dimensions	A	B	C	D	Thickness
PCUR022	32.8	13.5	23.9	-	7.9
PCUR023				11	
PCUR024	25.4	13.5	-	-	

Model		PCUR026	PCUR027
Length A	mm	52.4	
Diameter B (hole)	mm	12	15
Diameter C	mm	44	
Material		AISI 316	

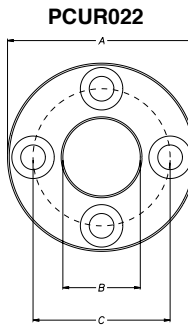

PCUR023

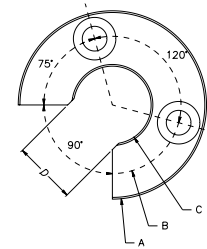

PCUR024

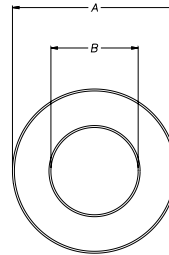

HEIGHT DETECTION POSITION

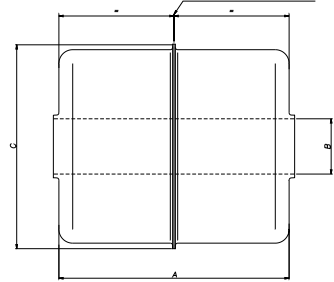

Note: PCUR026 and PCUR027 is supplied with kit PKIT036 for floating cursor for liquids.

OPTIONAL CONNECTORS (to order separately)

For **IK4-A-A** and **IK4-A-H**, M12 thread connector

CON031 and CON041 for 5 pin output (IK4-A-A)
 CON035 and CON042 for 8 pin output (IK4-A-H)

For **IK4-A-B** and **IK4-A-C**, M16 thread connector

CON021, CON022 and CON023 for 6 pin output (IK4-A-B)
 CON026, CON027 and CON028 for 8 pin output (IK4-A-C)

Connector extraction length 10mm

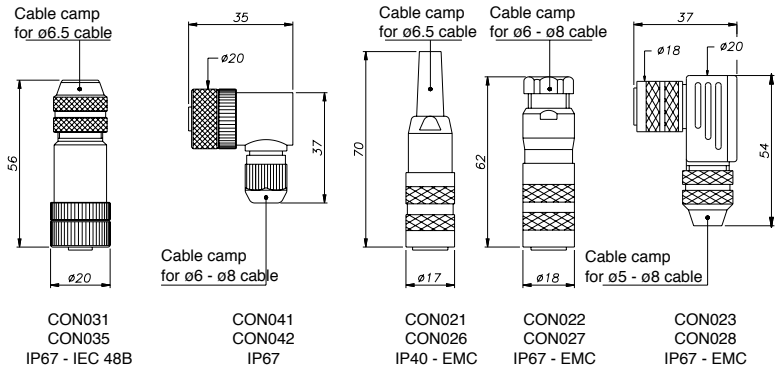

OPTIONAL OUTPUT CABLES (to order separately)

For **IK4-A-A**, cable with connector (straight or 90°) with M12 thread 5 pin

Lenght "L"		CODE	
		Straight cable	Cable to 90°
2	mt	CAV011	CAV021
5	mt	CAV012	CAV022
10	mt	CAV013	CAV023
15	mt	CAV015	CAV024

For **IK4-A-H**, cable with connector (straight or 90°) with M12 thread 8 pin

Lenght "L"		CODE	
		Straight cable	Cable to 90°
2	mt	CAV002	CAV005
5	mt	CAV003	CAV006
10	mt	CAV004	CAV007
15	mt	CAV009	CAV008

ACCESSORIES (to order separately)

Non-magnetic spacer for mounting PCUR022 cursor

CUR022

Sensors are manufactured in compliance with:
 - EMC 2004/108/CE compatibility directive
 - RoHS 2002/95/CE directive

Electrical installation requirements and Conformity certificate are available on our web site: www.gefran.com

GEFRAN spa reserved the right to make aesthetic or functional changes at any time and without notice.

GEFRAN spa
 via Sebina, 74
 25050 PROVAGLIO D'ISEO (BS) - ITALIA
 ph. 0309888.1 - fax. 0309839063
<http://www.gefran.com>

GEFRAN

DTS_IK4A_ONDA_09-2012_ENG