



Code 85198
Edition 12/2014

Contents

1. General precautions	pag 2
2. Transmitters with amplified analog output	pag 2
Standard installation	pag 2
Electrical connections series KH	pag 3
3. Protection for outdoor installations of analog sensors	pag 4
4. Technical specifications	pag 5
5. Safety (content according to IEC/EN 62061 paragraph 7)	pag 6

This manual is related to KH Series pressure transducer, SIL2 certified according to the standards IEC/EN62061

1. General Precautions

The system must be used only in accordance with the required protection level.

The sensor must be protected against accidental knocks and used in accordance with the instrument's ambient characteristics and performance levels.

The sensors must be powered with non-distributed networks and always at lengths of less than 30 mt.

In case of outdoor installations, follow the instructions in paragraph 3

2. Transmitters with amplified analog output

Transducers: KH SIL2 series

Outputs: 0.5...10.5V; 0.5...5.5V; 0.1...10.1V; 0.1...10V; 1...5V; 1...6V; 1...10V; 0.2...10.2; 0.5 ... 4.5V ratiometric; 4...20mA, etc...

Installation remarks

- The transducer must be grounded (normally through the machine body or equipment it is installed on).
- Use a shielded cable only. The cable shield must be grounded on PLC side and left floating on machine side (on KH version with M12 electrical connector it's possible to connect the shield on machine side by leaving floating the PLC side).
- To prevent interference, separate the power cables from the signal cables.

Standard installation (recommended)

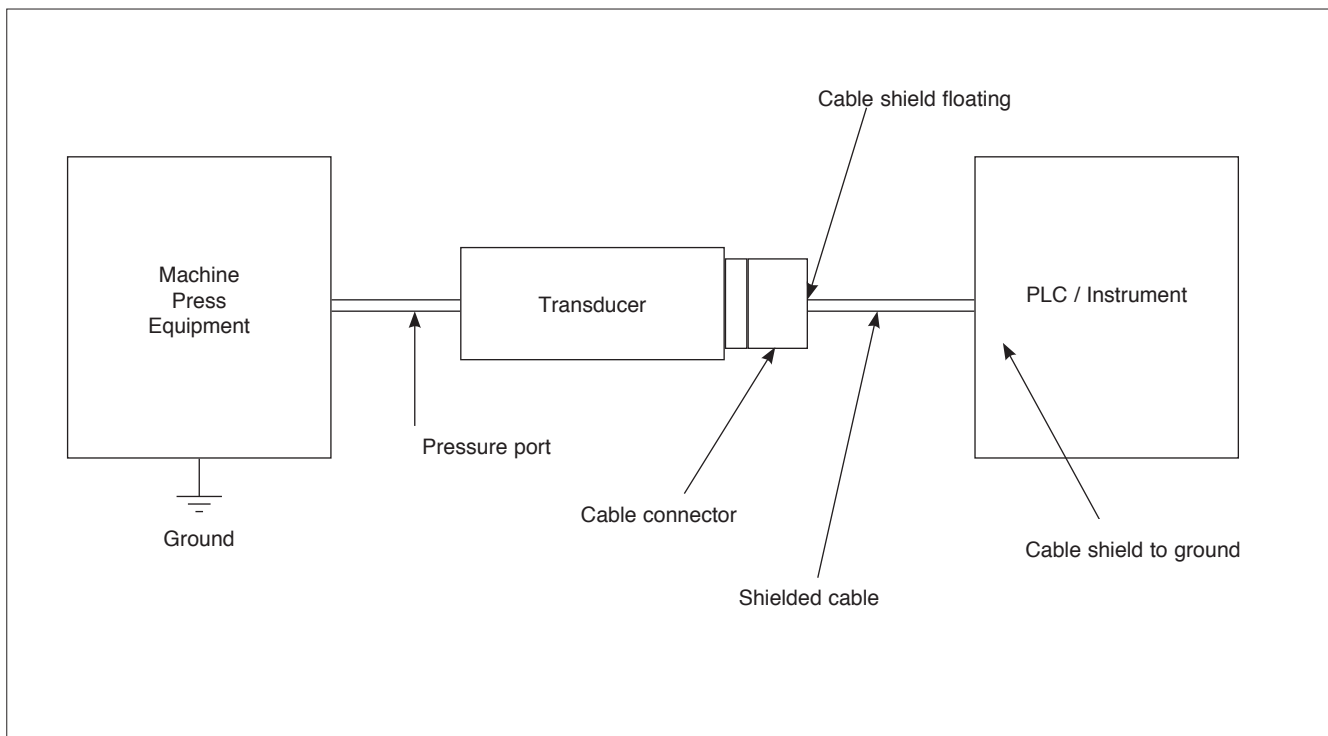

Electrical connections

RATIOMETRIC AND VOLTAGE AMPLIFIED OUTPUT

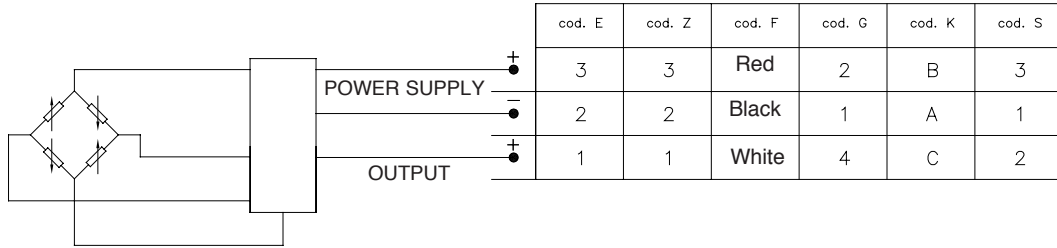

CURRENT AMPLIFIED OUTPUT – mod. E

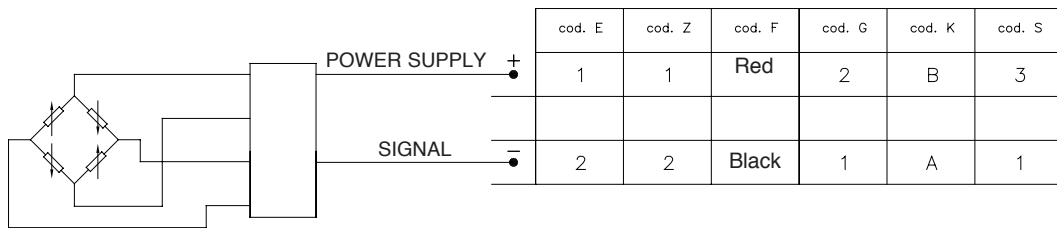

Interfaces with SRP/CS and voltage devices

The interface with SRP/CS (Safety Related Part of a Control System) is made by mean of multipolar connectors showed on pictures below, where the connections are specified in case of amplified voltage output (3 wire) or current output (2 wire system, the sensor is connected in series with the current loop).

LOAD DIAGRAM (Current output)

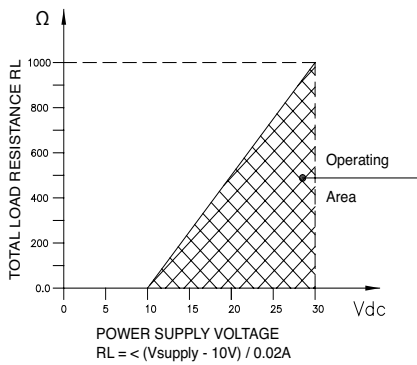

S – AMP Superseal 1.5

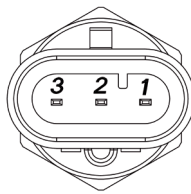

Protection IP67

F – 3 pole cable

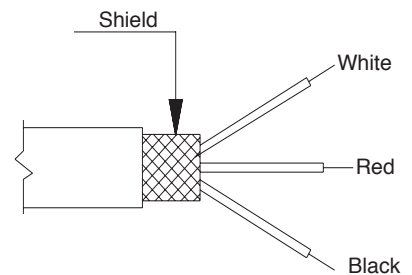

Protection IP65

Z - M12 x 1 (4 pin)

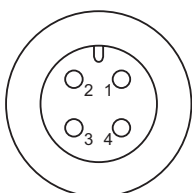

Protection IP67

E - EN 175301-803

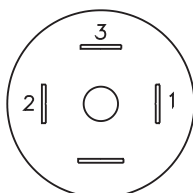

Protection IP65

G – Deutsch DT04-4P

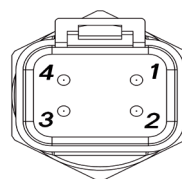

Protection IP67

K – Metri-Pack 150

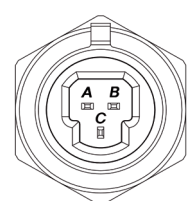

Protection IP67

3. Protection for outdoor installations of analog sensors

Pressure / Analog current output CAL signals if any do not require protection

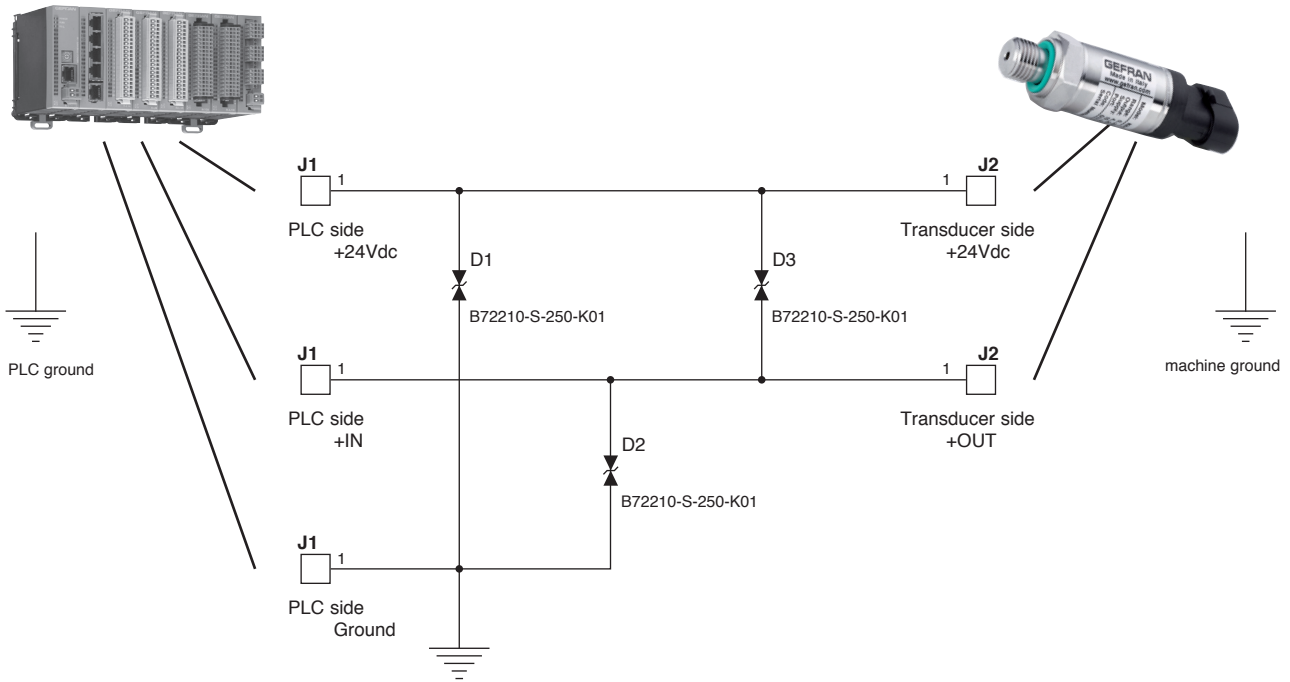

Pressure / Analog voltage output CAL signals if any do not require protection

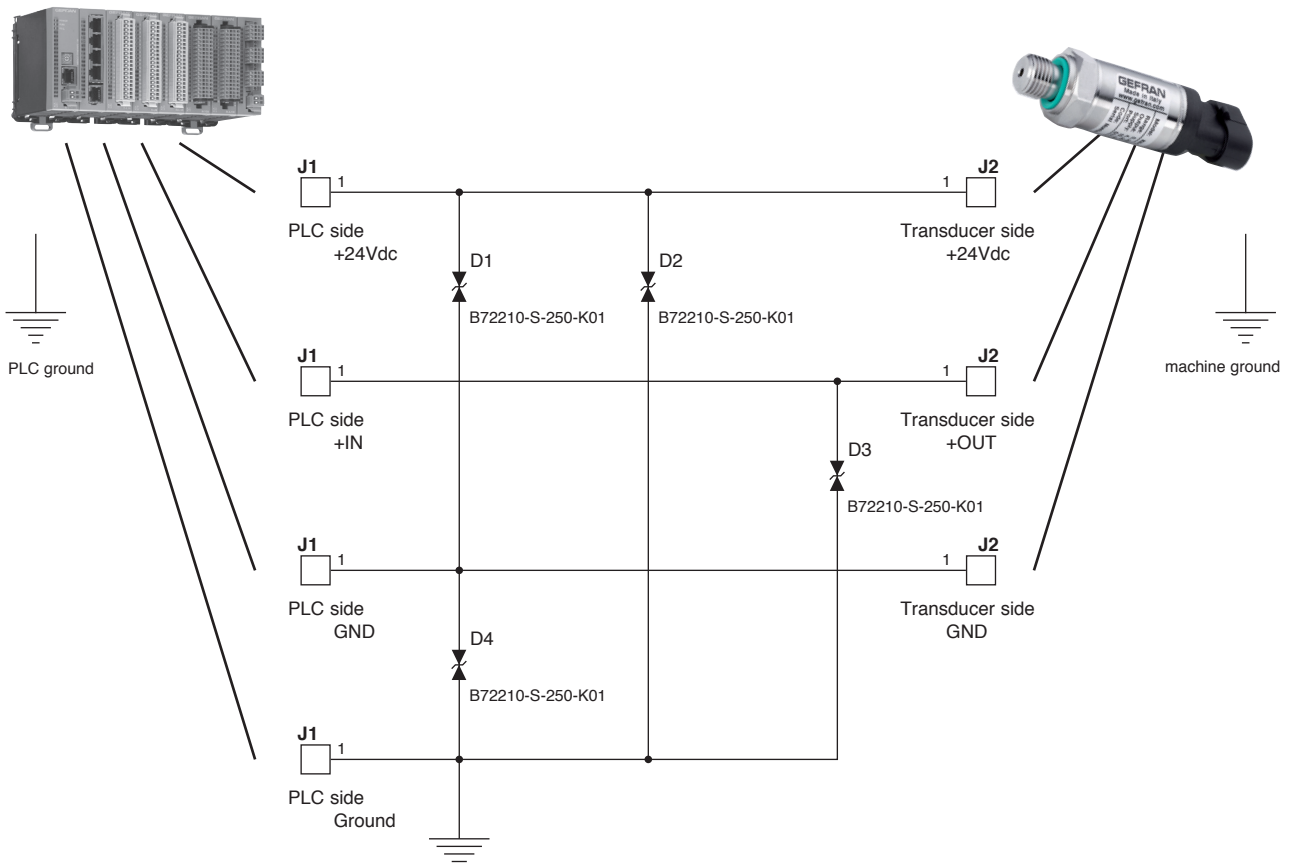

4. Technical specifications

Output signal	VOLTAGE	RATIOMETRIC	CURRENT
Accuracy at room temperature (1)	< ± 0.5% FS		
Pressure ranges (2)	From 4 bar to 1000 bar (See table)		
Overvoltage	32 Vdc max		
Overpressure (without degrading performance)	See table		
Pressure containment (burst test)	See table		
Pressure Media	Fluids compatible with Stainless Steel AISI 430F and 17-4 PH		
Housing	Stainless Steel AISI 304		
Power supply	15...30Vdc	5V ±0.25 V	10...30Vdc
Dielectric strenght	250 Vdc		
Zero output signal	0.1V; 0.2V; 0.5V; 1V (*)	0.5 V	4 mA
Full scale output signal	5V; 10V; 10.1V; 10.5V (*)	4.5 V	20 mA
Allowed load	≥ 5KΩ		see load diagram
Long term stability	< 0.2% FSO/per year		
Operating temperature range (process)	-40...+125°C (-40...+257°F)		
Operating temperature range (ambient)	-40...+105°C (-40...+221°F)		
Compensated temperature range	-20...+85°C (-4...+185°F)		
Storage temperature range	-40...+125°C (-40...+257°F)		
Temperature effects over compensated range (zero)	± 0.01% FS/°C typ (± 0.02% FS/°C max.)		
Temperature effects over compensated range (span)	± 0.01% FS/°C typ (± 0.02% FS/°C max.)		
Response time (10...90%FSO)	< 1 msec.		
Warm-up time (3)	< 30 sec.		
Mounting position effects	Negligible		
Humidity	Fino a 100%RH non-condensing		
Weight	80-120 gr. nominal		
Mechanical shock	100g/11msec according to IEC 60068-2-27		
Vibrations	20g max at 10...2000 Hz according to IEC 60068-2-6		
Ingress protection	IP65/IP67		
Output short circuit and reverse polarity protection	YES		
CE Conformity	According to EC Directive 2004/108/CE		
Electromagnetic compatibility-Emission	EN61326-1/EN61326-2-3		
Lifetime	10 years		

(*) Other voltage values of Zero and Full Scale available on request.

FS = Full scale
 1 Incl. Non-Linearity, Hysteresis, Repeatability, Zero-offset and Span-offset (acc. to IEC 61298-2)
 2 The operating pressure range is intended from 0.5% to 100% FS
 3 Time within which the rated performance is achieved

RANGE (Bar)	4	6	10	16	20	25	40	60	100	160	200	250	400	600	1000
Overpressure (Bar)	8	12	20	32	40	50	80	120	200	320	400	500	800	1200	1200
Burst pressure (Bar)	16	24	40	64	80	100	160	240	400	640	800	1000	1500	1500	1500

5. Safety (content according to IEC/EN 62061 paragraph 7)

Restrictions on use

The device in order to remain compliant with the designated category should be used only as indicated in these instructions and as required in the operating manual concerning mechanical installation, electrical connection, environmental conditions and usage limits.

Maintenance and periodic inspections

Periodic maintenance to carry-out in order to guarantee the justified exclusion of failures are:

- Visual inspection of the status of the electrical and mechanical connections.

The maintenance is designed to evaluate possible problems due to situations of incorrect mounting endured over time or particular aggressiveness of the material processed.

Frequency: every two years

Check obstruction of the channel under pressure

- The maintenance has the purpose to verify that there are no occlusion of the pressure channel, which would lead to malfunctioning.

The inspection is visual, after removing the probe from the process seat.

Frequency: every year.

Testing the sensor calibration

- The test is intended to check the correctness of the transduction curve of the sensor. It's done by applying known pressure points to the transducer and checking the output values of the probe.

Frequency: every four years.

Indication of response time

The response time to the pressure transduction is equal to 1 ms

Indications and alarms

The KS Series pressure sensors in the case of some specific anomalies provide output saturation (positive HIGH or negative LOW).

The table 1 indicates the detected failures, their effect on the electrical output, and the recovery mode of the device.

Table 1: failures, effects on the outputs

Failure	Current output	Voltage output		Ratiometric
		FS ≤ 6V	FS > 6V	
				Power supply 5V
Power supply cable broken	LOW < 3.8mA	LOW < 0.05 V		LOW < 0.25 V
Sensor not connected	LOW < 3.8mA	LOW < 0.05 V		LOW < 0.25 V
Power supply broken	LOW < 3.8mA	LOW < 0.05 V		LOW < 0.25 V
Broken bridge	*LOW < 3.8mA	*LOW < 0.05 V		*LOW < 0.25 V
	*HIGH > 22mA	*HIGH > 7 V	*HIGH > 11.5 V	*HIGH > 4.75 V
(*) variable according to the type of failure				

Failures and troubleshooting

In case of failures or malfunctions, on Table 2 you can find the most common failures and the means of appropriate search:

Table 2: troubleshooting

Failure	Possible causes	Means of research
The sensor does not feel pressure	Obstruction of pressure channel Fault on electronics output stage	1. Power down and remove the sensor 2. Verify eventual occlusion of the channel under pressure. Clean any residues and material caps
The sensor is in alarm mode type "HIGH"	Bridge broken Detachment of pins Failure on primary element	1. Power down and remove the sensor 2. Check for overheating of electronics housing. Remove the causes of overheating, wait until it cools down and power the sensor. 3. Powered the probe again, if the problem persists, you should send back the probe to Factory for repair.
The sensor is in alarm mode type "LOW"	Power supply cable /connector broken Sensor not connected Sensor not powered Bridge broken	1. Power down and remove the sensor 2. Check that the power supply is connected. If necessary, restore the power supply. 3. Check for continuity between the pins of the connector and the power supply. If necessary, replace the cable and the connector. 4. Check if the power values are within the specifications indicated in this manual. If necessary, replace the power supply. 5. If the problem persists, you should send back the probe to Factory for repair.

Applications to use the relevant category

The pressure sensors of KH Series may form part of a system for detecting the pressure that, when a threshold value is exceeded, deactivates all the elements of pressure generation, through a control system.

The diagram "A" (Fig. 1) shows a possible application: the sensor detects the pressure and transduces it in an analog electrical signal proportional to the value of the measured value; the SRP / CS compares the signal with the one set as the alarm threshold: in case of exceeding the threshold it shall disable the elements of pressure generation.

VOLTAGE OUTPUT and RATIO-METRIC

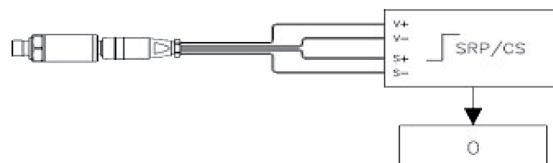

CURRENT OUTPUT

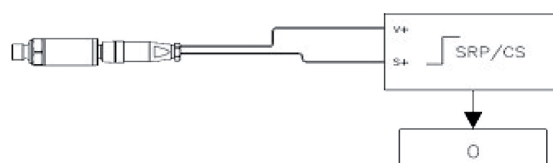

Fig. 1: application diagram A

GEFRAN

via Sebina, 74 - 25050 PROVAGLIO D'ISEO (BS) - ITALIA
tel. 0309888.1 - fax. 0309839063 - Internet: <http://www.gefran.com>